

VÁLVULAS

PARA CONTROLE DE PRESSÃO

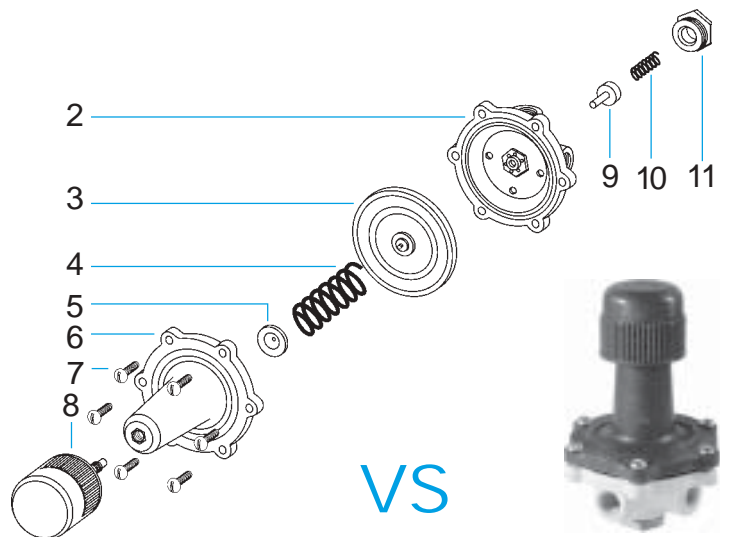
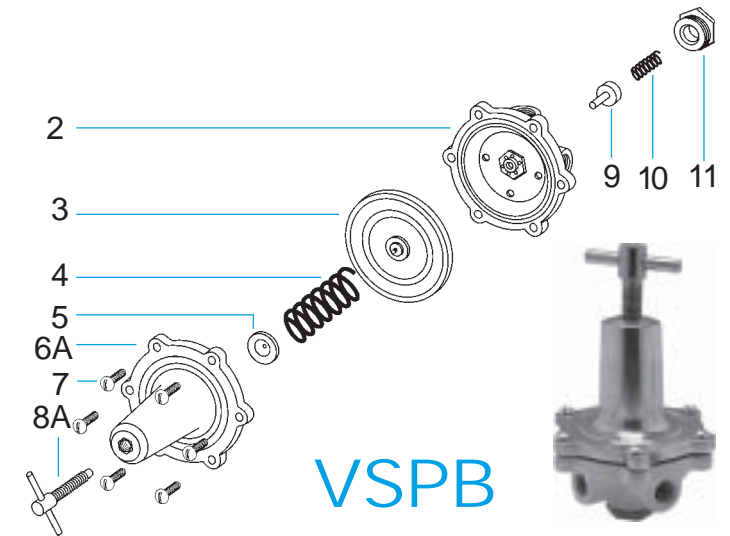
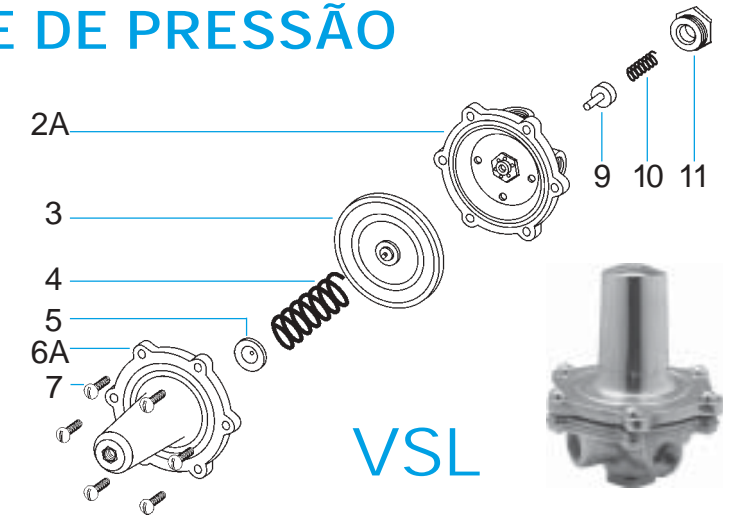
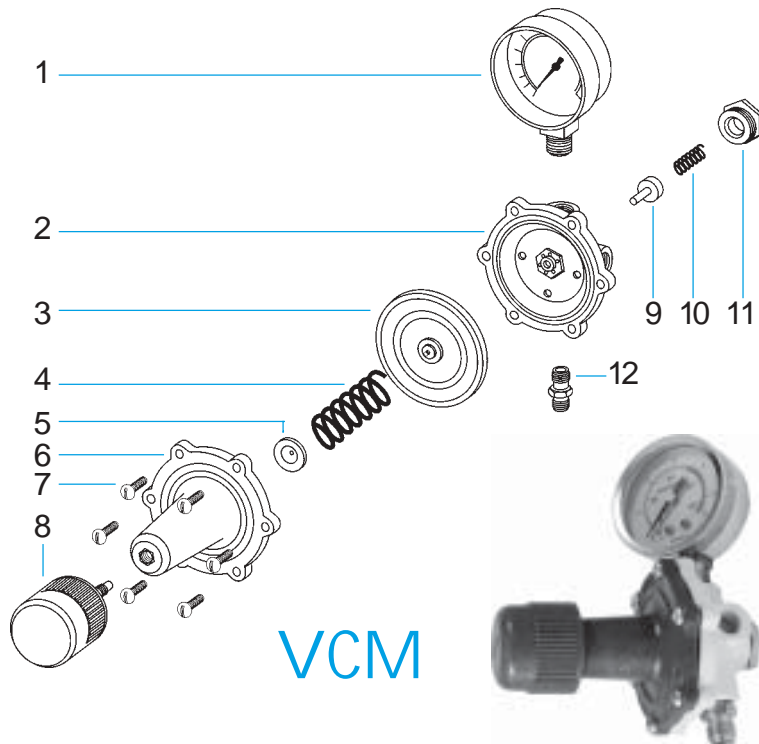
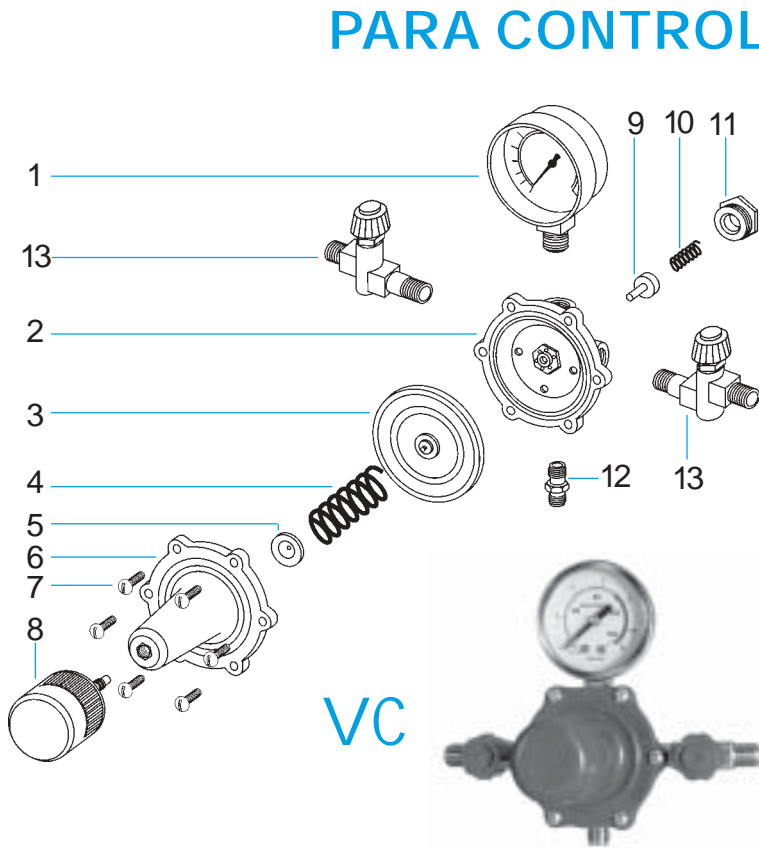

PRODUTOS IDEAIS PARA:

CONTROLE DE PRESSÃO.

VÁLVULAS

PARA CONTROLE DE PRESSÃO

VC

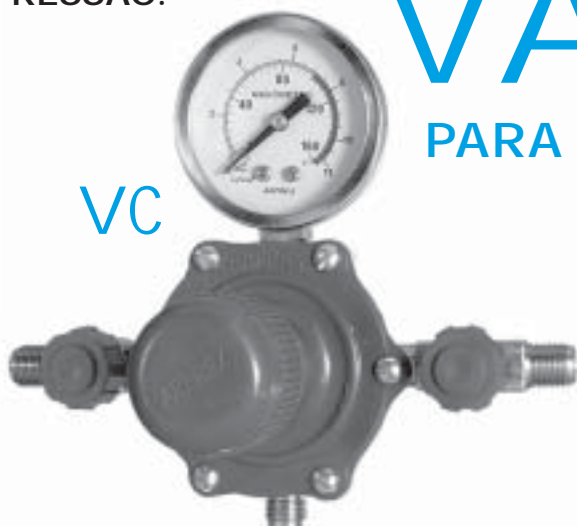

VS



VCM

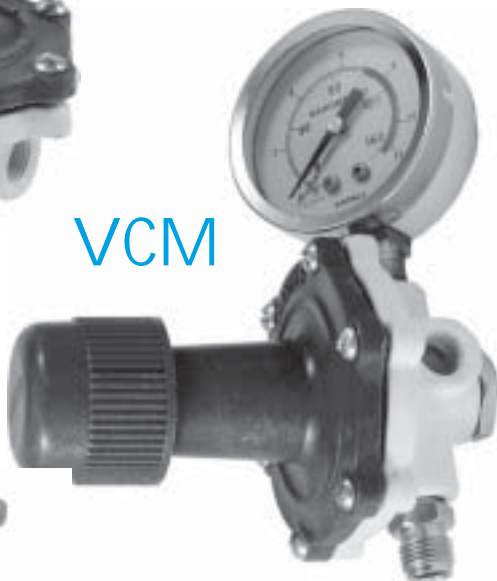

VSPB

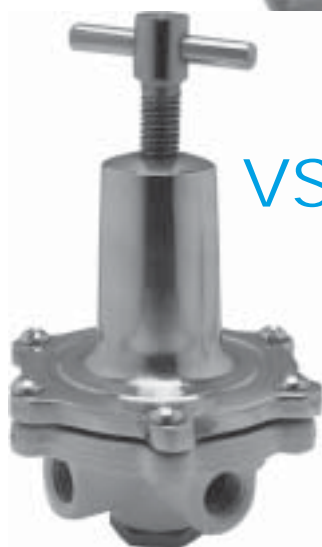

VSL



VC
VS
VCM
VSPB
VSL

REF.	CÓDIGO	DESCRIÇÃO	QDE.
1	10702130	Manômetro	01
2	10701034	Corpo da válvula alumínio	01
2A	10704030	Corpo da válvula latão	01
3	10701041	Diafragma Conjunto	01
4	10701130	Mola da canopla	01
5	10701164	Pastilha	01
6	10701031	Canopla de nylon	01
6A	10717030	Canopla de alumínio	01
7	10701162	Parafuso de fixação da canopla	06
8	10701023	Botão da canopla	01
8A	10717160	Parafuso borboleta	01
9	10701033	Copinho de vedamento	01
10	10701131	Mola do copinho de vedamento	01
11	10701200	Tampão da válvula	01
12	10113050	Entrada de ar	01
13	10702200	Torneira completa	02

PA018 - JAN/05



Produtos

ARPREX

EQUIPAMENTOS PARA PINTURA MAJAM LTDA.

Av. João XXIII, 1.386 - V. Formosa

Cep 03361-001 - São Paulo-S.P.

Fone: (11) 6100-8100 - Fax: (11) 6211-9173

www.arprex.com.br